

Straight Jack Receptacle

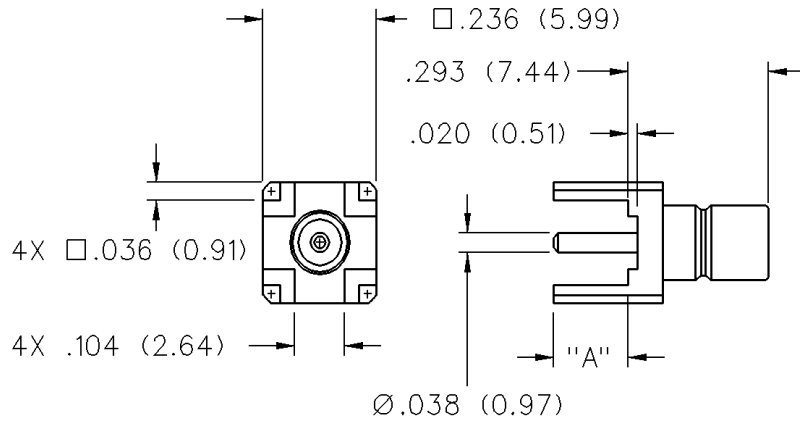

ØAÓ	GOLD PLATED
.095 (2.41)	131-9701-211

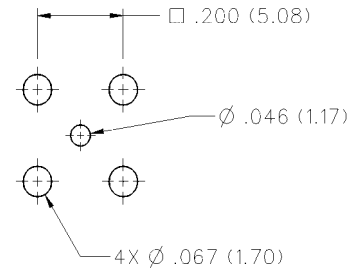

SPECIFICATIONS

ELECTRICAL RATINGS

Impedance: 50 ohms

Frequency Range: 0-4 GHz

VSWR: (f = GHz)

	Straight Cabled	Right Angle Cabled
RG-316	1.25 + .04f	1.35 + .04f
Uncabled receptacles	N/A	

Working Voltage: (Vrms maximum)

Connectors for Cable Type	Sea Level	70K Feet
RG-316, uncabled connectors	335	85

Dielectric Withstanding Voltage: (VRMS minimum at sea level)

Connectors for RG-316, uncabled receptacles	1000
---	------

Corona Level: (Volts minimum at 70,000 feet)

Connectors for RG-316	250
Uncabled receptacles	N/A

Insertion Loss: (dB maximum, tested at 1.5 GHz)

Straight cable connectors	0.30 dB
Right angle cable connectors	0.60 dB
Uncabled receptacles	N/A

Insulation Resistance: 1000 megohms minimum

Contact Resistance: (milliohms maximum)

	Initial	After Environmental
Center contact (straight cabled connectors and uncabled receptacles)	6.0	8.0
Center contact (right angle cabled connectors)	12.0	16.0
Outer contact (gold plated connectors)	1.0	1.5
Braid to body (gold plated connectors)	1.0	N/A

RF Leakage: (dB minimum tested at 2.5 GHz)

Cable connectors	-55 dB
Uncabled receptacles	N/A

RF High Potential Withstanding Voltage: (Vrms minimum, tested at 4 and 7 MHz)

Connectors for RG-316	700
Uncabled receptacles	600

Power Rating (Dummy Load): 0.5 watt @ +25°C, derated to 0.25 watt @ +125° C

MECHANICAL RATINGS

Engagement Design: MIL-STD-348, Series SMB

Engagement/Disengagement Force: 2 pounds min to 14 pounds maximum axial force

Contact Retention: 4 lbs. min axial force (captivated contacts)
1 inch-ounce min torque (uncabled receptacles)

Cable Retention:	Axial Force* (pounds)	Torque (in-oz)
Connectors for RG-316	20	N/A

*or cable breaking strength whichever is less.

Durability: 500 cycles minimum

ENVIRONMENTAL RATINGS

(Meets or exceed the applicable paragraph of MIL-PRF-39012)

Temperature Range: - 65°C to + 165°C

Thermal Shock: MIL-STD-202, Method 107, Condition B

Corrosion: MIL-STD-202, Method 101, Condition B

Shock: MIL-STD-202, Method 213, Condition B

Vibration: MIL-STD-202, Method 204, Condition B